

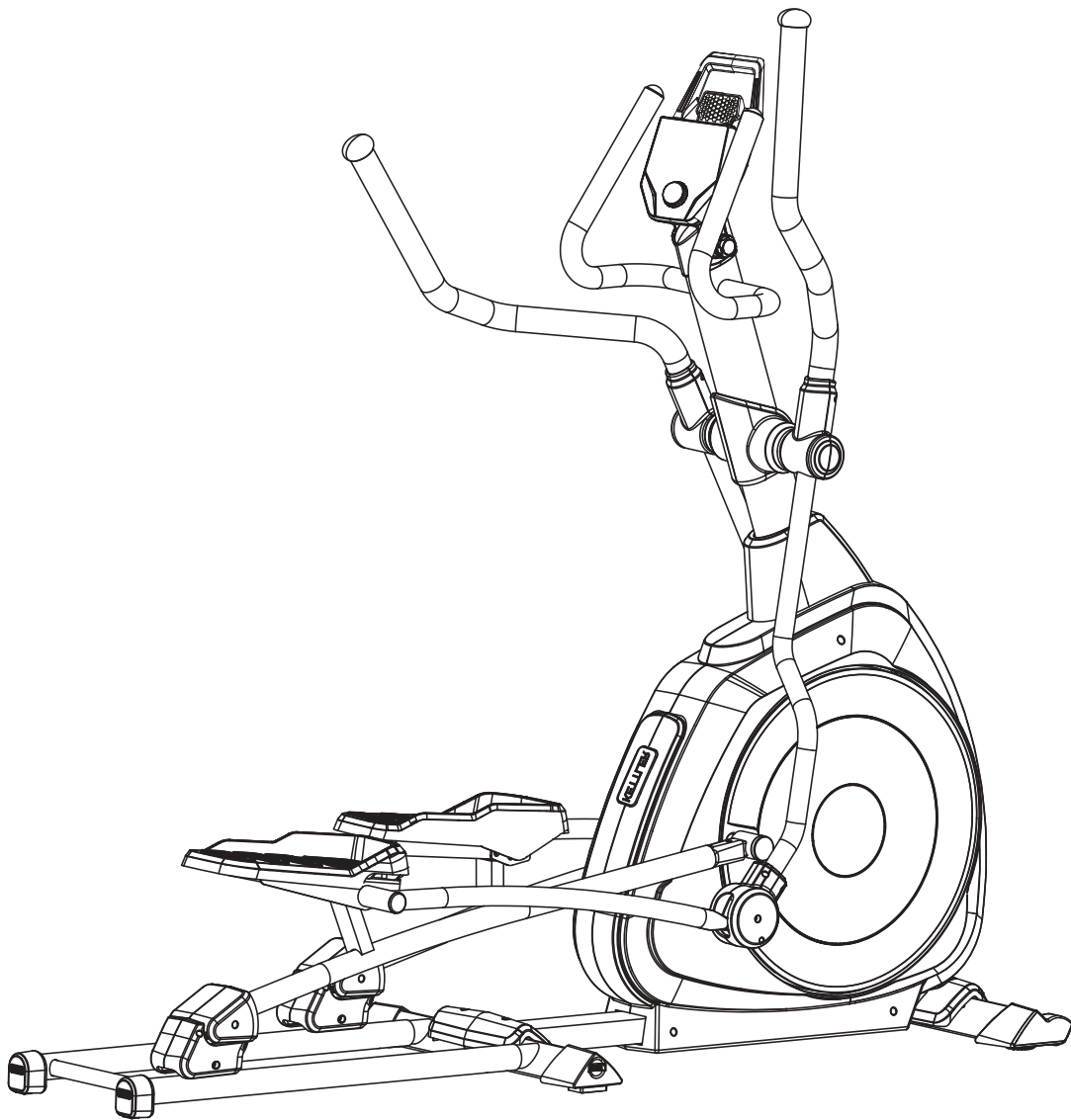

# STYLON



**Record serial number**



*Elite STYLON Elliptical*

Thank you for purchasing the **Elite Stylon Elliptical**.

For over 30 years, Elite Fitness™ has been New Zealand's largest supplier of fitness equipment. Our aim and vision is to provide you Elite™ branded products, tested to the highest standard for quality and biomechanics at the best possible price.

Please read through this manual to familiarise yourself with the operation of your new **Elite STYLON**. Doing so will help to ensure that you get the most out of your machine, enjoying safe and effective workouts ahead.

Even though we go to great efforts to ensure the quality of each product we produce, occasional errors and or omissions do occur. In any event should you find this product to have either a defective or a missing part, please contact us for a replacement.

## **SERVICE & WARRANTY**

For service and warranty assistance please visit:

**[www.elitefitness.co.nz/service](http://www.elitefitness.co.nz/service)**

Online forms are available for Service, Warranty and Parts requests.

(09) 258 9067

### **Elite Fitness HQ**

28 Morrin Road

St Johns

Auckland, New Zealand

[info@elitefitness.co.nz](mailto:info@elitefitness.co.nz)

0800 2 438 348

## **CONTENTS**

---

Important Safety Instructions	<b>3</b>	Maintenance Log	<b>21</b>
Product Specifications	<b>4</b>	Limited Warranty	<b>22</b>
Check List	<b>5</b>	Warm-Up Exercise	<b>23</b>
Parts List	<b>6</b>	Training Stages	<b>24</b>
Assembly Instructions	<b>7</b>		
Exploded Drawing	<b>16</b>		
Display Console	<b>17</b>		
Care and Maintenance	<b>20</b>		

# IMPORTANT SAFETY INSTRUCTIONS

---

The following definition applied to the word “WARNING” when used in this manual:



**WARNING**

Used to call attention to POTENTIAL hazards that could result in personal injury.

## READ ALL INSTRUCTIONS BEFORE USING THE MACHINE

This product has been designed for **home use only**. Product liability and warranty conditions will not be applicable to products being subjected to professional use or products being used in a commercial environment. e.g Gym Centre, Retirement Centre, Home Based PT Studio and Physio.

This exercise machine is built for optimum safety. However, certain precautions apply whenever you operate a piece of exercise equipment. Be sure to read the entire manual before you assemble or operate your machine. In particular, note the following safety precautions.

- Read all instructions in this manual before using this equipment.
- Use the machine only for its intended use as described in this Manual.
- Inspect and tighten all the loose parts before this equipment is used.
- Keep hands away from moving parts.
- Keep children and pets away from the machine at all times. **DO NOT** leave children unattended in the same room with the machine.
- Before using the machine to exercise, always do stretching exercises to properly warm up.
- Inspect the machine before each use; make sure all of the connections are tightly secured.
- Only one person at a time should use the machine.
- If the user experiences dizziness, nausea, chest pain, or any other abnormal symptoms, **STOP** the workout at once. **CONSULT A PHYSICIAN IMMEDIATELY.**
- Position the machine on a clear, levelled surface. **DO NOT** use the machine near water or outdoors.
- Always wear appropriate workout clothing when exercising. **DO NOT** wear robes or other clothing that could become caught in the machine. Sporting shoes are recommended when using the machine.
- Do not place any sharp object around the machine.
- Disabled persons should not use the machine without a qualified person or physician in attendance.
- Never operate the machine if the machine is not functioning properly.
- Only carry out training work on the equipment when it is in perfect working order. Only use original spare parts in the event of a repair.
- Do not use strong solvents for cleaning, and only use the tools supplied, or suitable ones of your own, for any repairs that may be required. Please dispose of the packaging and any parts that have to be replaced subsequently (all parts for the unit) at suitable collecting points or containers with a view to saving the environment.
- **DO NOT** extend the seat stem past the warning line “Max” when adjusting the seat height.
- Not for therapeutic use.

**WARNING:** Before beginning any exercise programme, consult your physician. This is especially important for persons with pre-existing health problems. The seller assumes no responsibility for personal injury or property damage sustained by or through the use of this product.

**SERVICE HINTS:** The high quality standard of this product only will be kept if you, on a regular basis, check all screw connections and moving parts on proper fitting. Damaged parts need to be changed immediately. During the time of repair the product must not be used by anybody.

**IMPORTANT HINTS:**

- A) This product has been tested in accordance with the requirements of EN 957-1/A1, EN 957-5, standard, Class HA (HOME USE). The maximum load is limited to 130 KGS.
- B) Parents should be aware of the risk factor of young children playing on fitness equipment unattended. Make sure that children are instructed properly in the use of the product and in the controlled execution of the different exercises. Misuse of the product could result in serious injury.

## **PRODUCT SPECIFICATIONS**

---

User Weight Capacity: 130 kg

---

Dimensions: 185 x 68x 164 cm

---

Shipping Weight: 82.4 kg

---

Net Weight: 74 kg

---

Power Requirements 2 x AA batteries

---



# PARTS LIST

	Stck. 1
 YM6723L-11-E-S	1
	1
 4x M8x16	1
	1
 6x M8x20 6x 2x M4x16	1
	1
	1
 2/2x M5x14	1
	1
	1
	1

		2
	M8x655	4
	M8x45	2
	M8x40	4
	M8x16	6
	M8x20	4
	ø 8,5x19	12
	ø 8x25	4
	ø 8,5x19	4
	ø 8	4
	ø 17,5x25	4
		2
	M 8	4
	3x16	15
	3x25	4

We recommend 2 people assist in assembling this unit. Place all parts of the exercycle in a cleared area and remove the packaging. Do not dispose the packaging until assembly is completed. Before you start the installation, inspect and prepare all parts and screw features.

# ASSEMBLY INSTRUCTIONS

## STEP 1

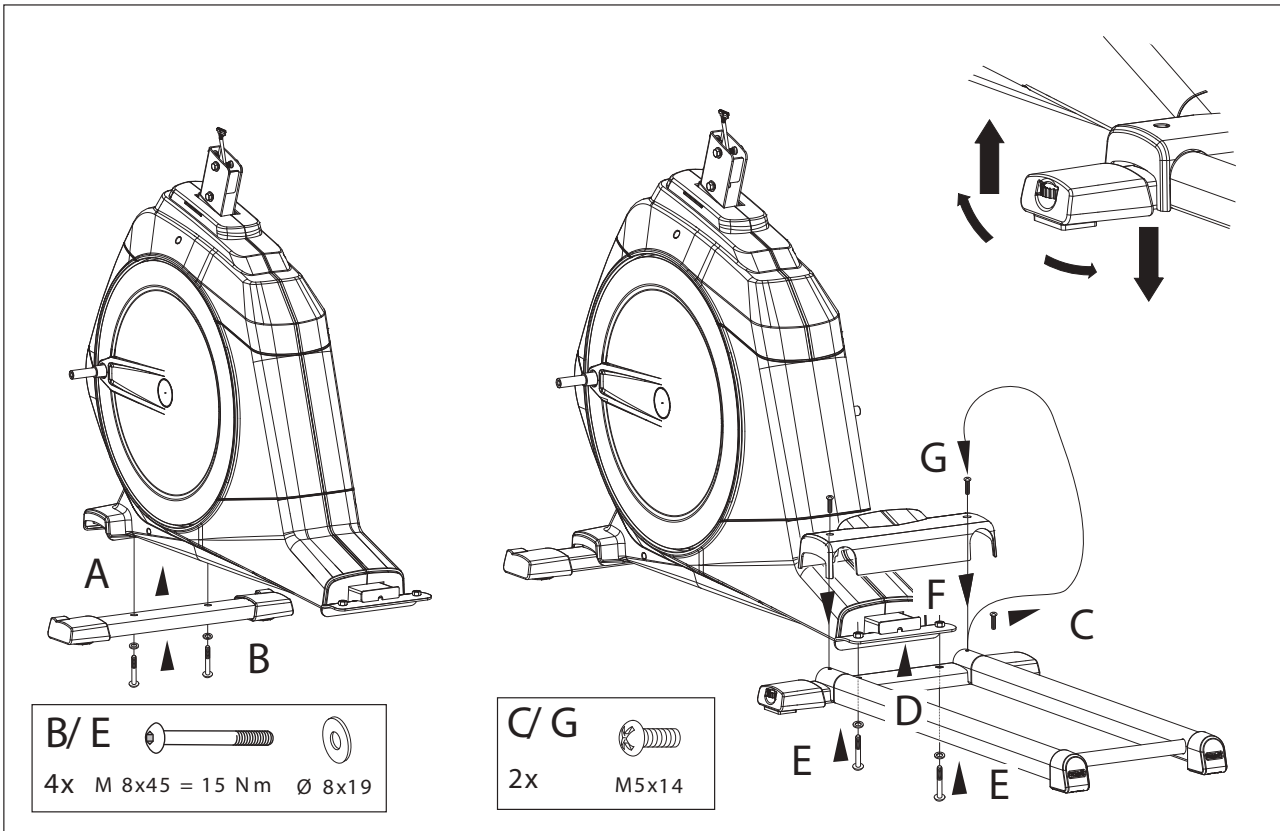
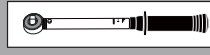

## STEP 2

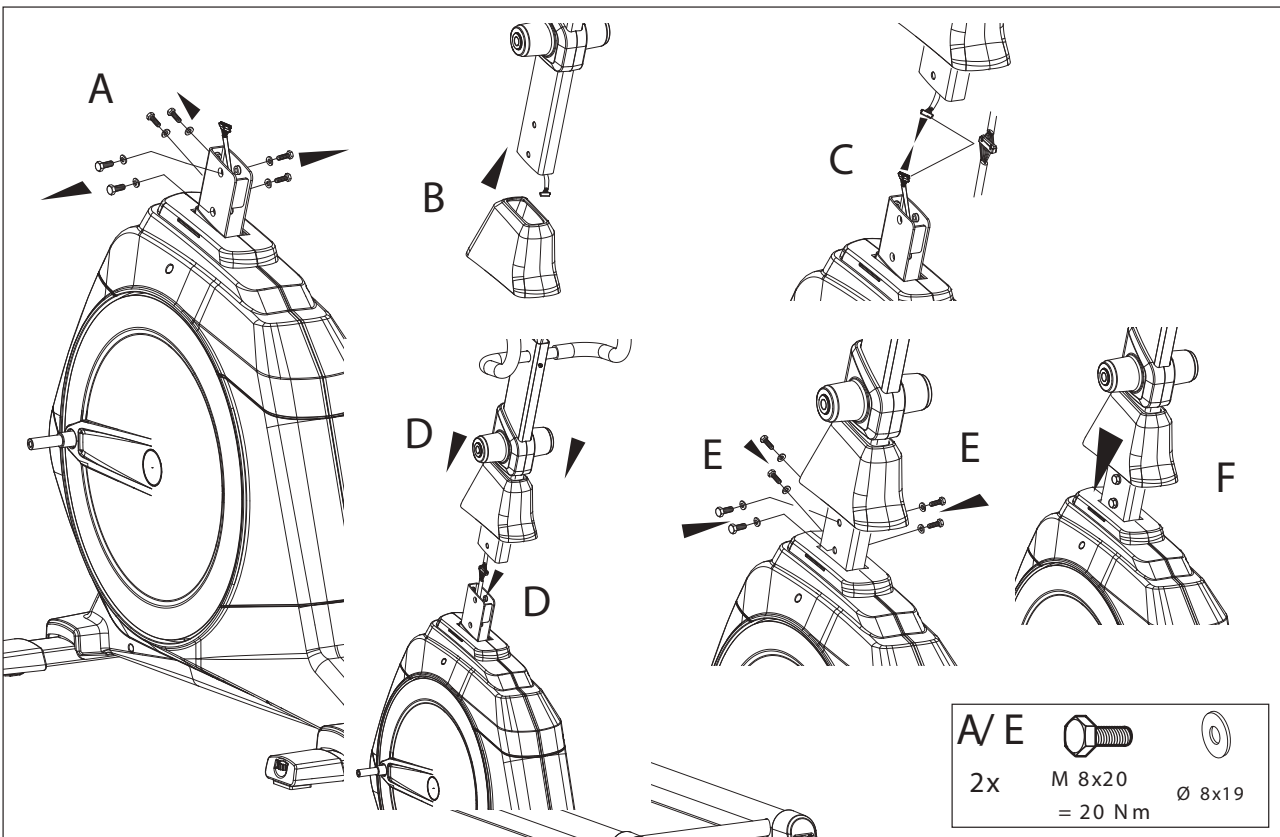
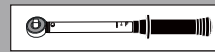

# ASSEMBLY INSTRUCTIONS

## STEP 3

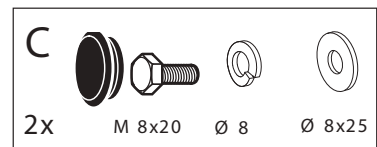
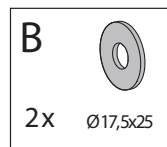
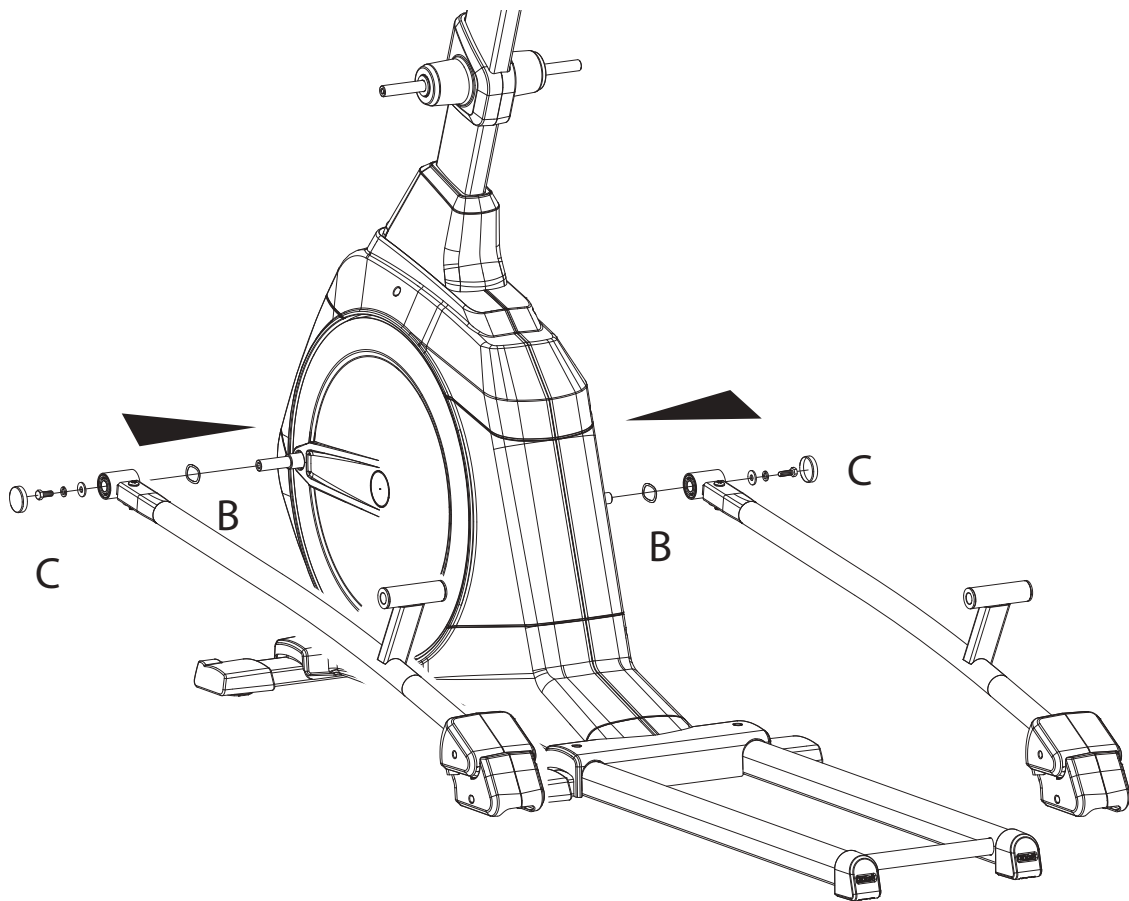
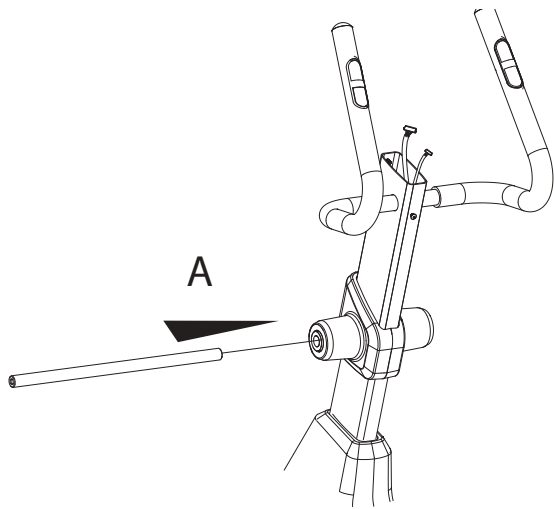

# ASSEMBLY INSTRUCTIONS

## STEP 4

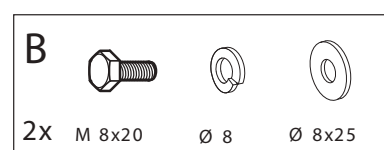
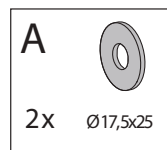
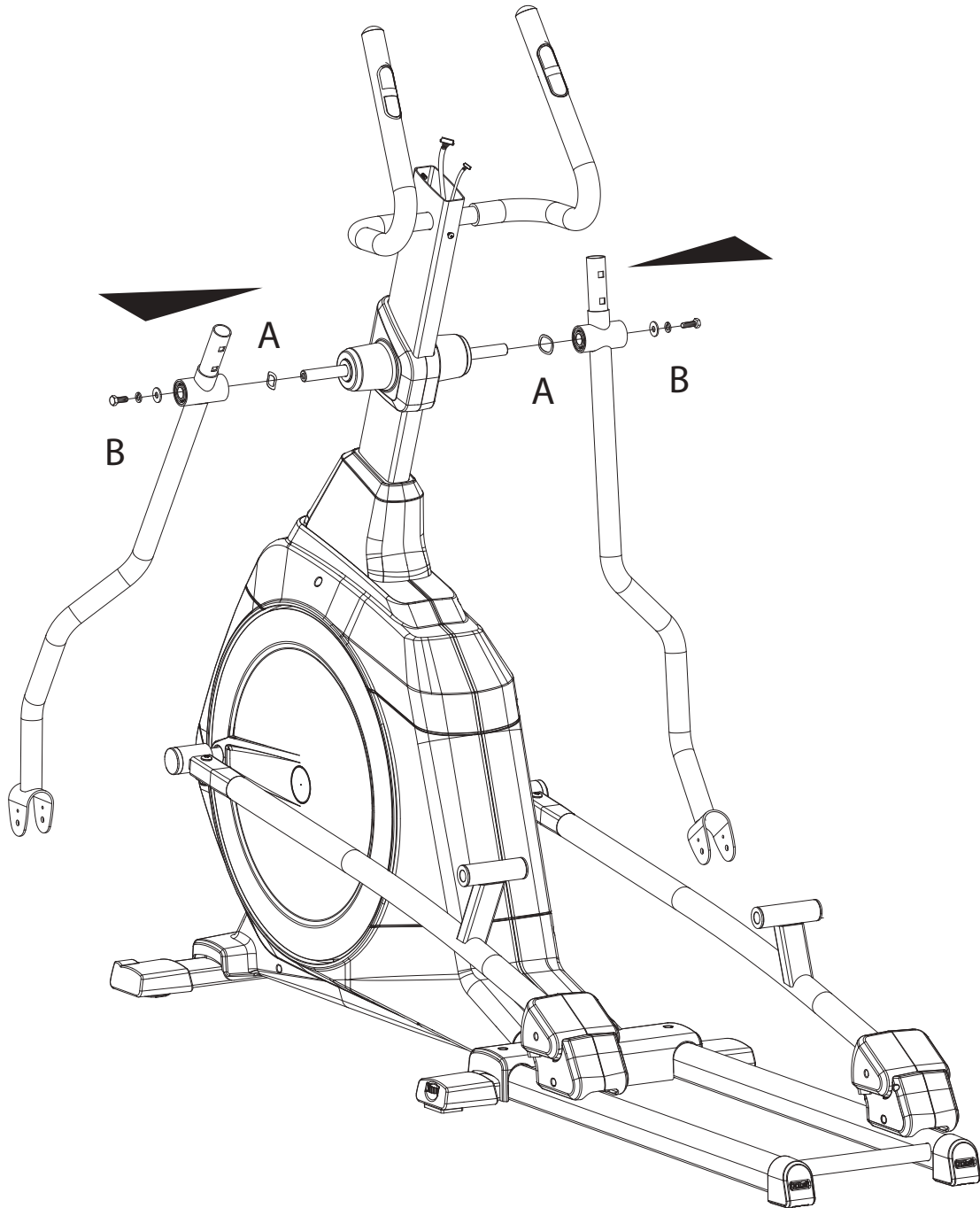

# ASSEMBLY INSTRUCTIONS

## STEP 5



2x

A C

C			B	
6x	M 8x16	Ø 8x16	2x	2x

2x

E E D

E			
2x	M 8x55	Ø 8x16	M 8

2x

G G J F

F/i		J	
2x	M 5x14	6x	ST 3x16

L L K K L

L	
4x	M 8x16

# ASSEMBLY INSTRUCTIONS

## STEP 6

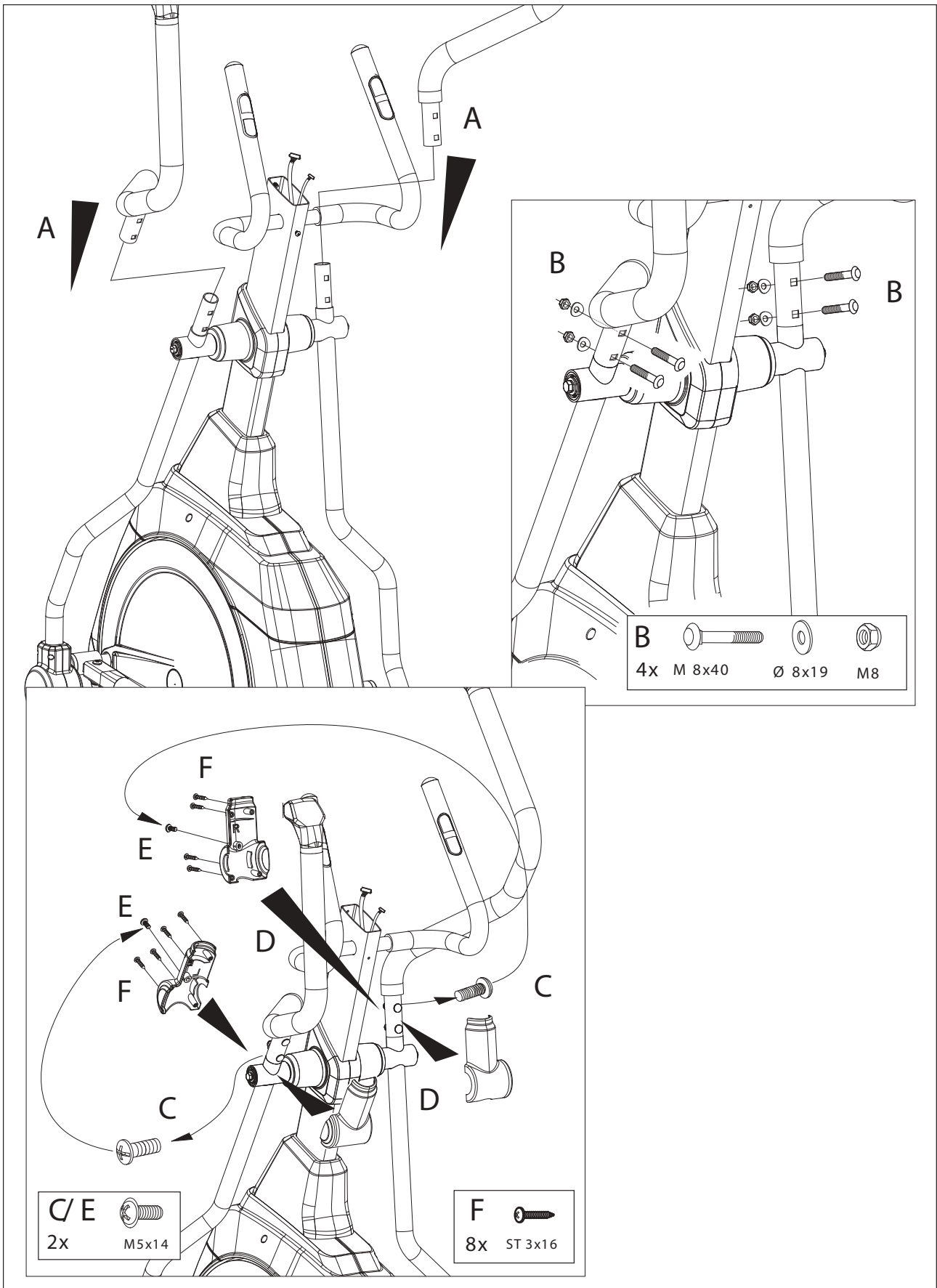

# ASSEMBLY INSTRUCTIONS

## STEP 7

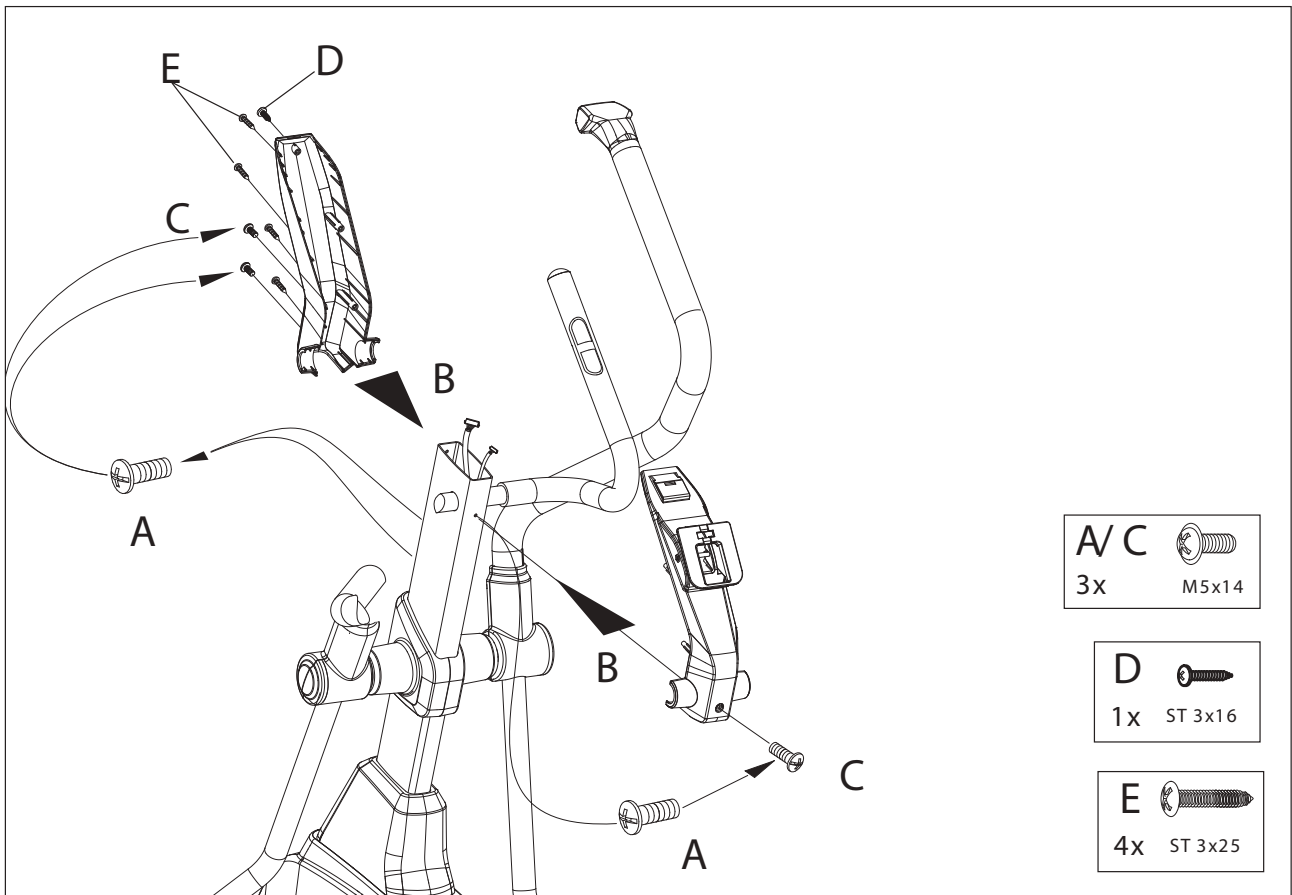

## STEP 8

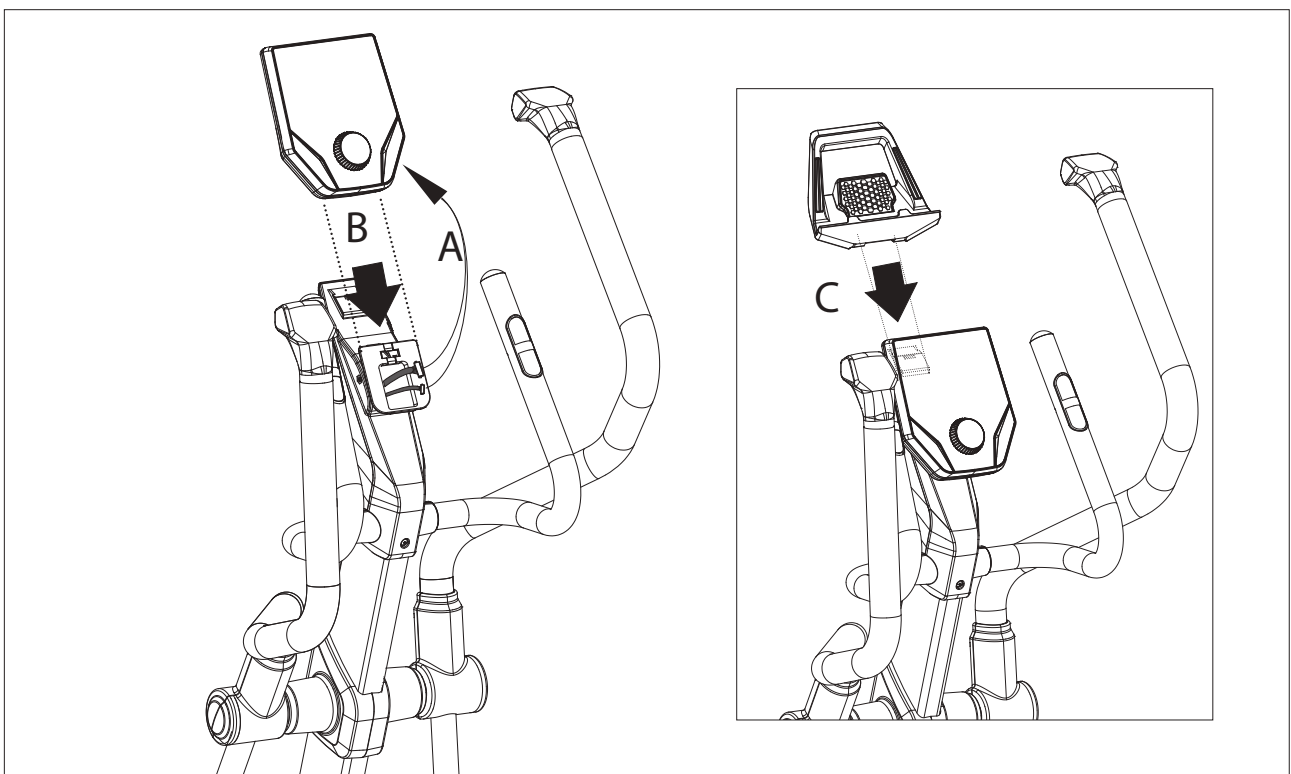

# ASSEMBLY INSTRUCTIONS

## HANDLING

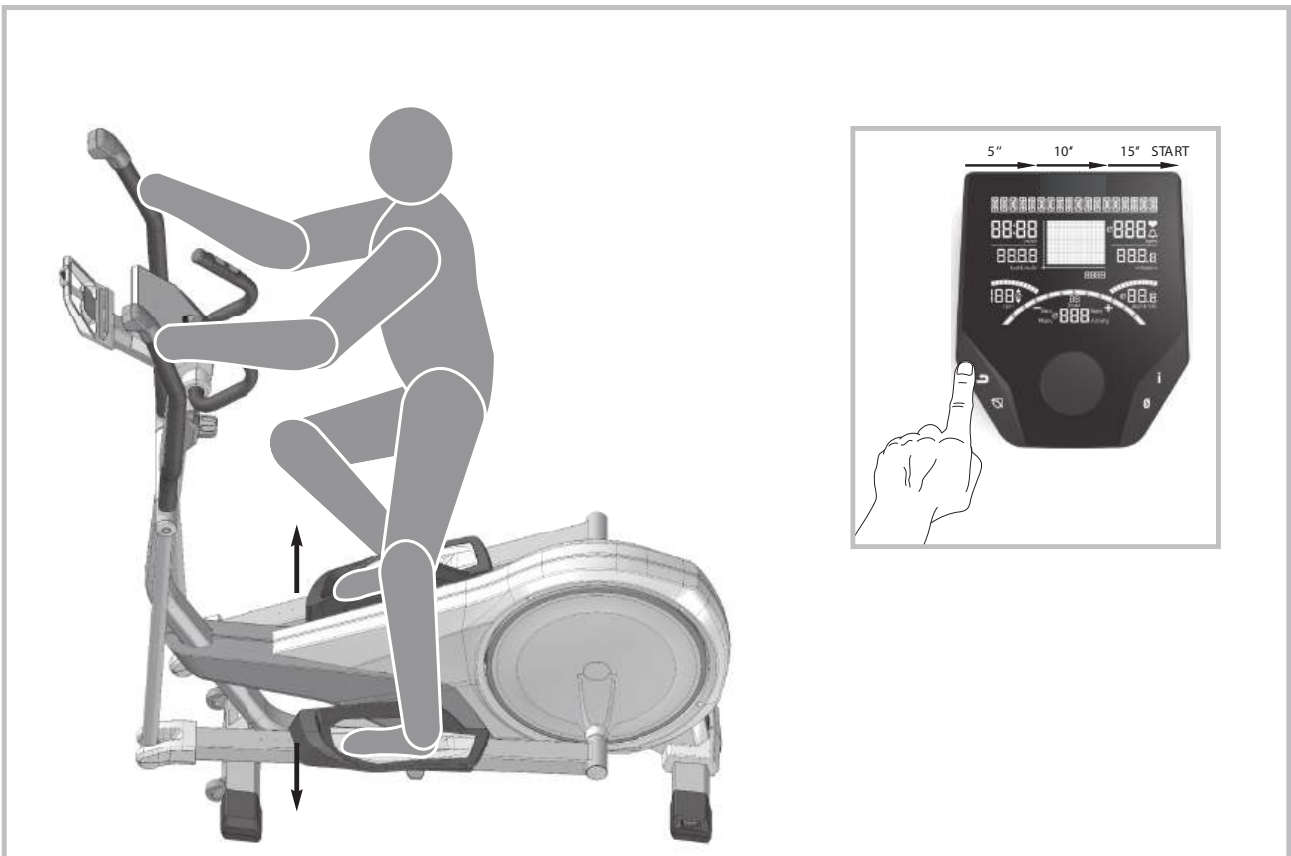
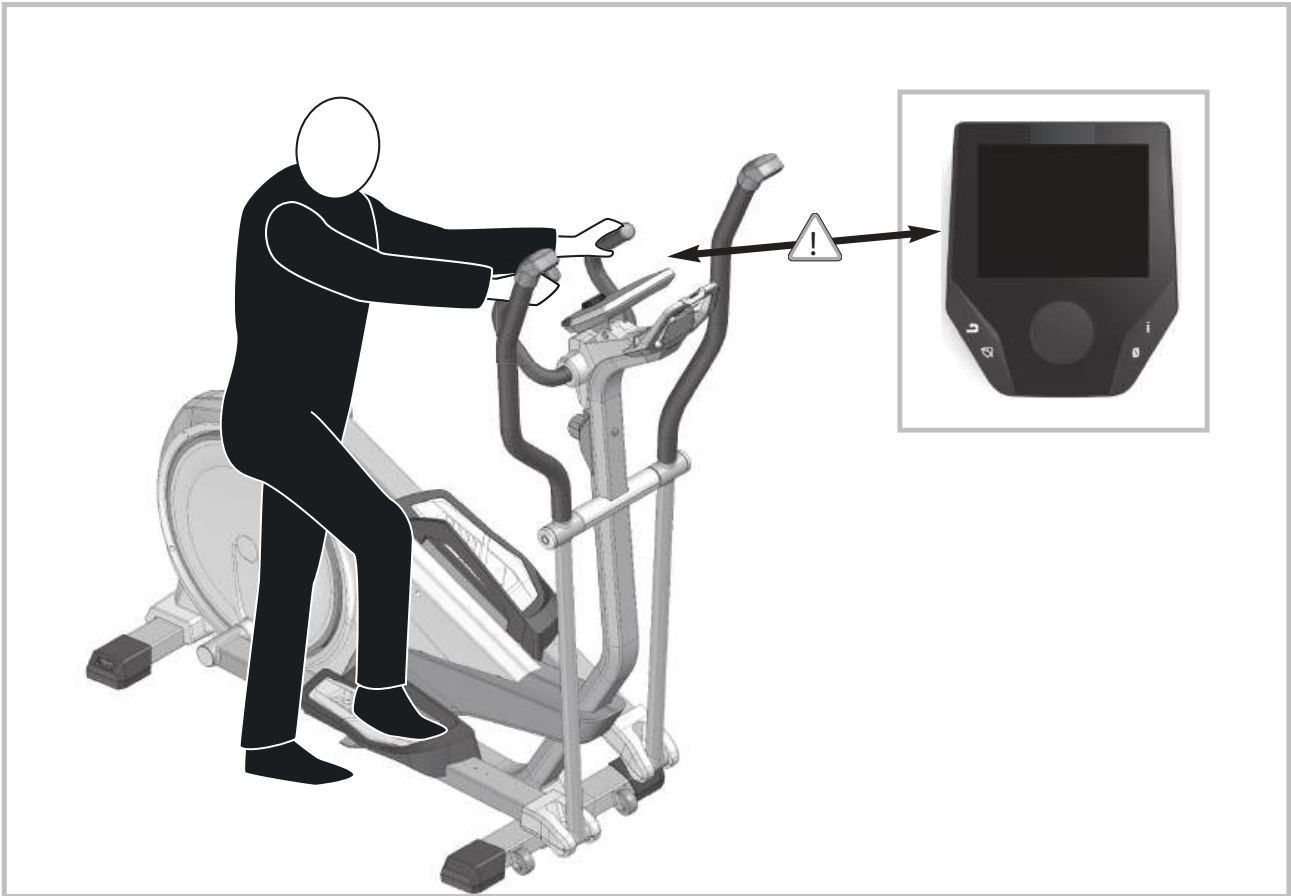

# ASSEMBLY INSTRUCTIONS

## HANDLING

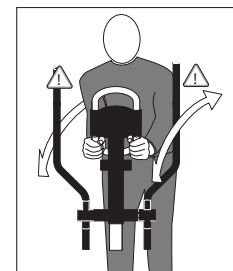
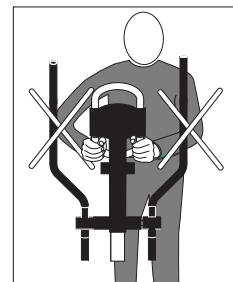
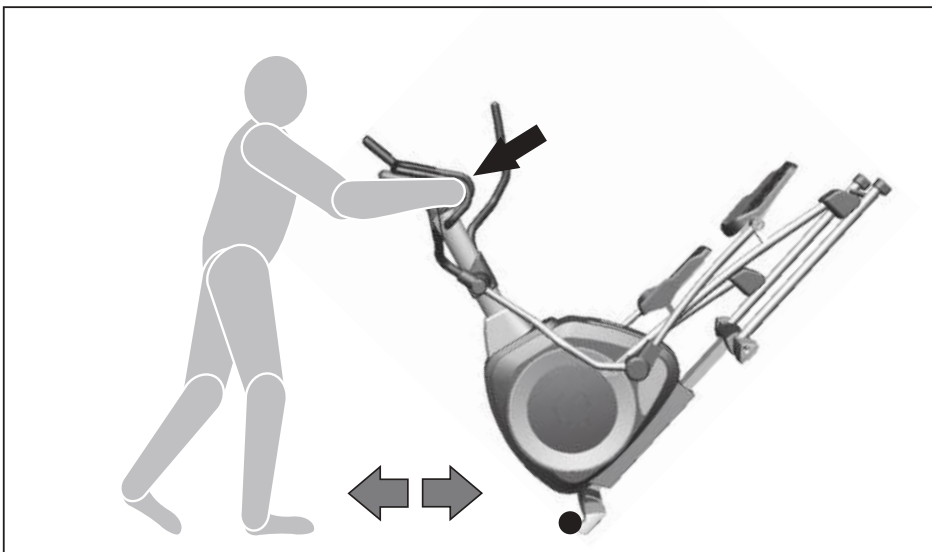
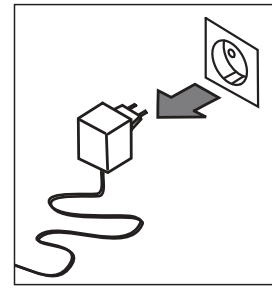
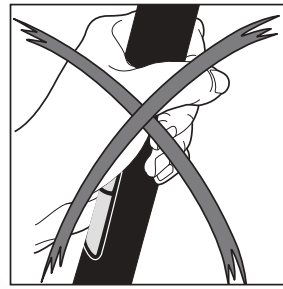
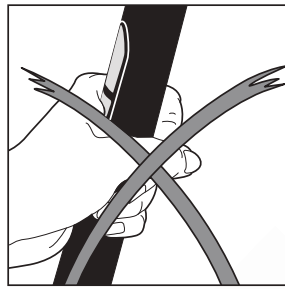
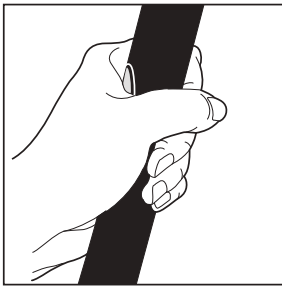

## BATTERY CHANGE

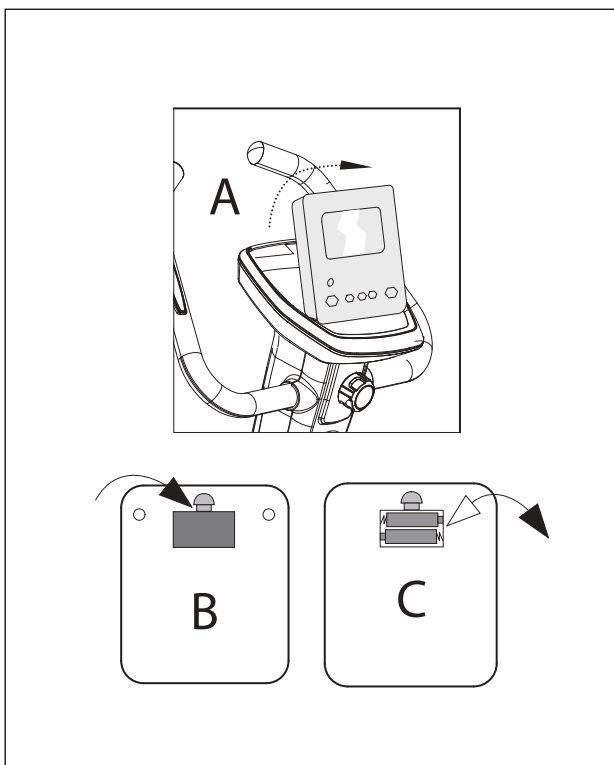

A weak or an extinguished computer display makes a battery change necessary. The computer is equipped with two batteries. Perform the battery change as described below:

- Remove the lid of the battery compartment and replace the batteries by two new batteries of type AA 1,5V.
- When inserting the batteries pay attention to the designation on the bottom of the battery compartment.
- Should there be any misoperation after switching on the computer again, shortly disconnect the batteries once again and re-insert them.

Important: The guarantee does not cover worn-out batteries.

Disposal of used batteries and storage batteries



This symbol tells you that batteries and storage batteries must not be disposed of with the normal household waste. The symbols Hg (mercury) and Pb (lead) underneath the crossed-out rubbish bin also tell you that the battery or storage battery contains more than 0.0005% mercury or more than 0.004% lead.

Improper disposal damages the environment and can damage people's health. Recycling of materials conserves precious raw materials. When disposing of the appliance, remove all batteries and storage batteries from the product and hand them over to the collection point for the recycling of batteries or electrical or electronic appliances.

# ASSEMBLY INSTRUCTIONS

## CONGRATULATIONS

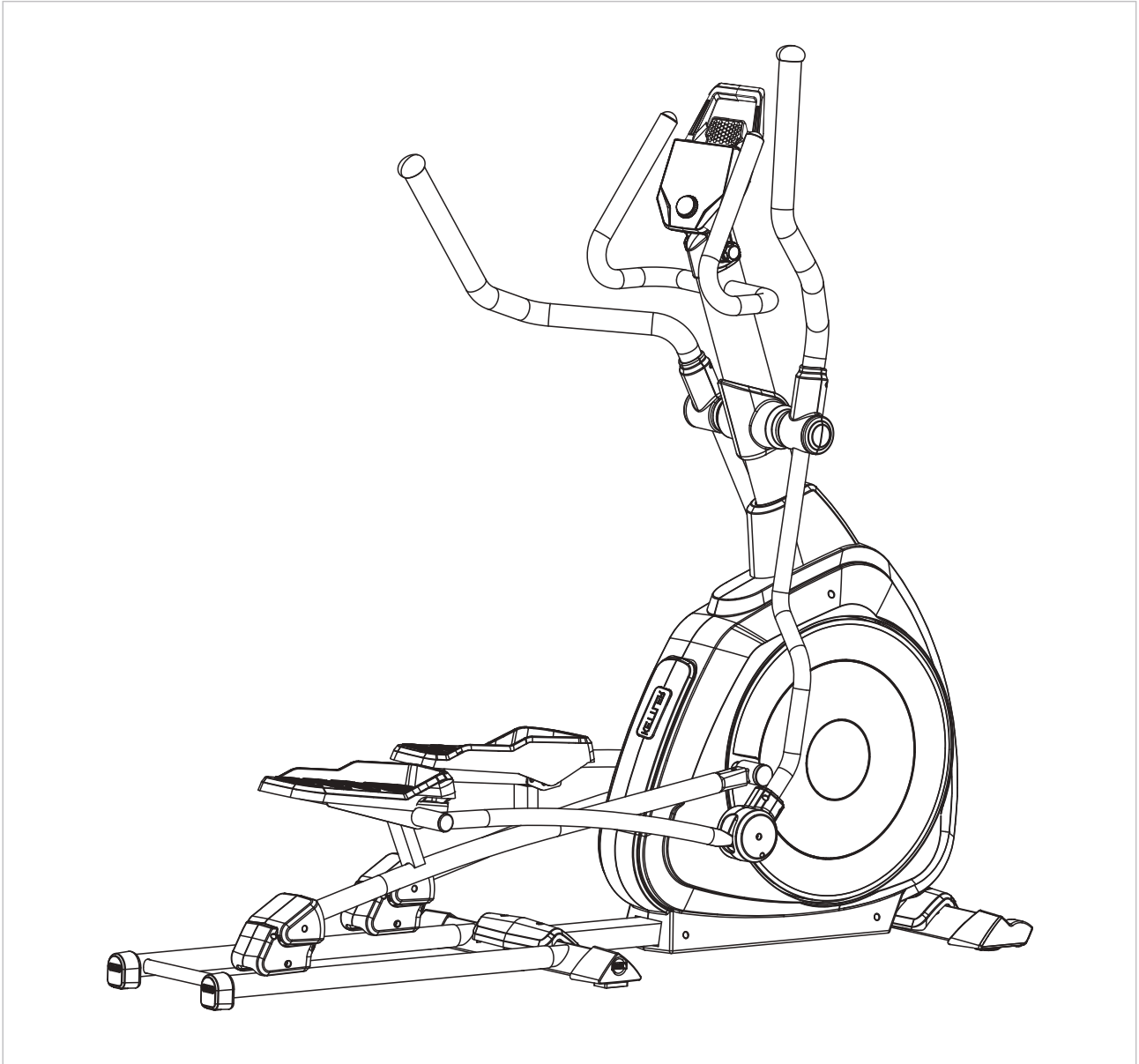

Assembly of your **Elite STYLON Elliptical** is now complete! Be sure to fully inspect your machine before using it for the first time.

### **⚠ WARNING**

Failure to visually check and test the assembly of your elliptical before use can cause damage to the elliptical, serious injury to users and bystanders and can also compromise the effectiveness of your exercise program.

# EXPLODED DRAWING

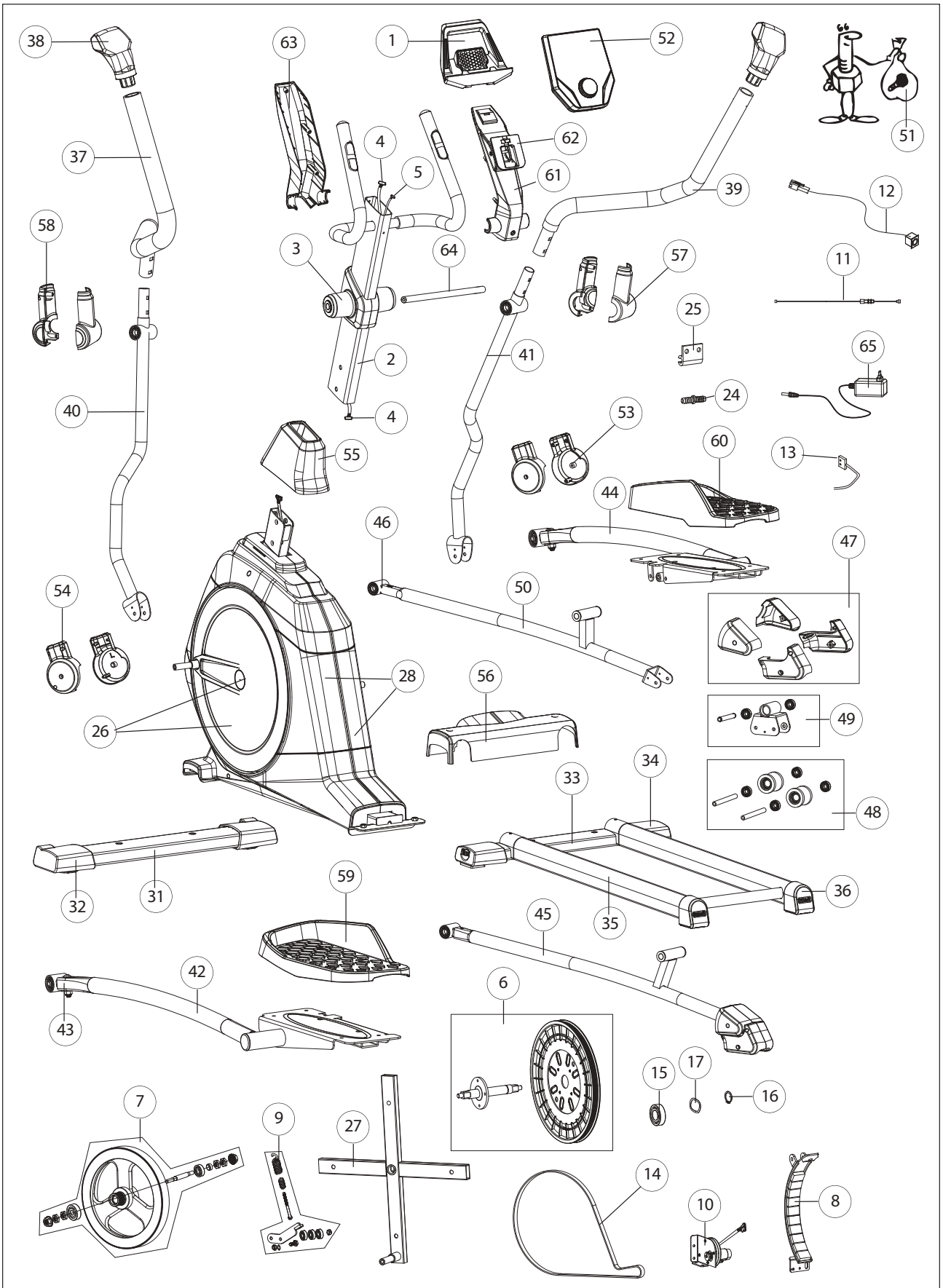

# DISPLAY CONSOLE



- ① **Display:** The display provides all important information about your workout. Once the display is turned on you will see the Menu List. You will be able to create User Settings, select Training Programs and read your workout results.

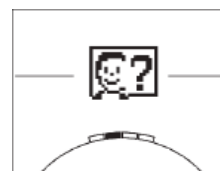

When a Training Program is selected you will have all important workout scores and the Training Profile on your display.

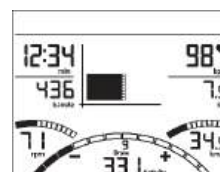

- ② **Central Key (PRESS):** By pressing the Central Key you confirm the selected item.
- ③ **Central Key (TURN):** By turning the Central Key you can change the selection in the Menu. Or you can use to change the resistance during your workout.
- ④ **Return Key:** By pressing the Return Key you will go back to the main Menu. Any changes made will not be saved.
- Recovery Key:** By pressing the Recovery Key you will end your Training Program and start the recovery pulse measurement. If you press again you can return to the Training Program.
- ⑤ **Information Key:** By pressing the Information Key you will go to the contextual information, where you have the Menu items explained with more detail.

**Average Scores/ Values Key:** By pressing the Average Score/ Values Key you will display the average scores/ values for a few seconds.

**PLEASE NOTE:** If the machine is not intended to be used for any period longer than 4 weeks, please remove the batteries from the console to avoid any corroding and a potential damage.

# DISPLAY CONSOLE

## Main Menu

User Selection



**Machine Settings**

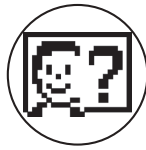

**Guest Users**



**Individually Set Users**

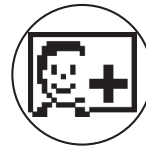

**Adding New Users**

This menu is primarily for selection of the user on whose account the Training Session is to take place.



**Machine Settings:**

With this you can change the machine settings: language, units of measurement and etc.



**Individually Set Users:**

You can set up to 4 individually users



**Guest Users:**

It gives you the option to do your workout without a preset. The results will not be saved and no personal settings may be made.



**Adding New User:**

A new user can be added. Name and age are requested. Once you finish a new user is integrated.

## User Menu

User Personal Account



**Personal Settings**



**My Results**



**My Last Training Session**



**My Training Program List**

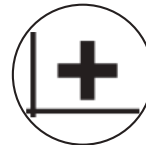

**Training Program Configurator**



**Personal Settings:**

You will be able to change the user personal settings e.g: age, name and etc.



**My Last Training Session:**

This item is always preselected once you select the User Menu.



**My Results:**

You will find the personal overall performance achieved and results from the last workout.



**My Training Program List:**

In this list you will find all training sessions that have been saved.



**Training Program Configurator:**

For each user, you will have storage space for an individually configured Training Program. Through configuration of a new Training Program, the previous Training Program is overridden.

# DISPLAY CONSOLE

## Training Program List

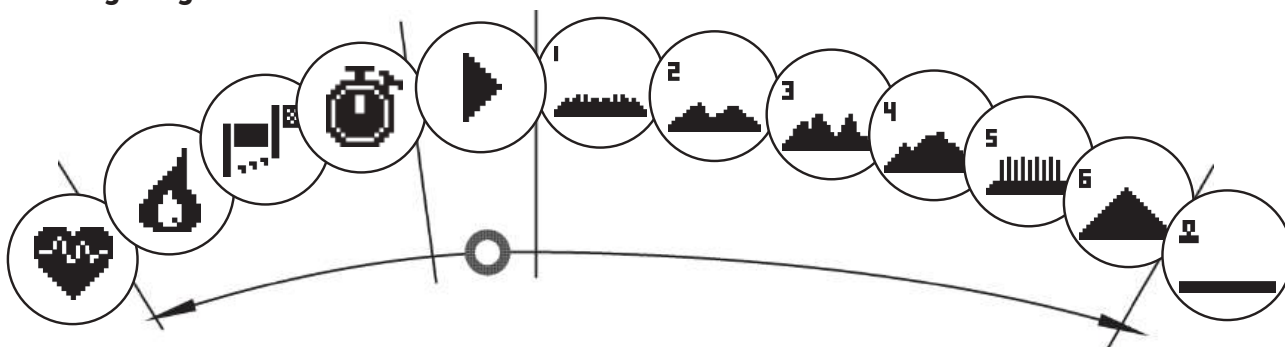

### **Quick Start:**

This is preset and all score/values are set at zero and you can decide about the duration and intensity.



### **Heart Rate Oriented Training Program (HRC):**

You can target a certain heart rate range you want to reach. The resistance will be set accordingly. The central graphic will display if you are above, below or reaching the desired heart rate.

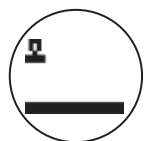

### **Self-Configured Profile:**

Here you can set your individual Training Program.



### **Training Programs w/ Targets:**

Set yourself a personal target (time, distance or calories) for your workout. The Training will start with a countdown from the desired target to zero.

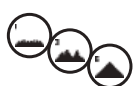

### **Profile Training Sessions (1 - 6):**

The elliptical will automatically change the resistance, following the program. 1 - 3 Moderate, 4 - 6 Difficult.

## Recovery Pulse Measurement

Once you press the Recovery Pulse key during your workout the measurement will begin after 10 seconds.

The device will measure your pulse in a 60-second countdown.

Subsequently, the recovery pulse grade will be displayed. The display will end after 20 seconds or by pressing the Recovery Pulse key. If no pulse is registered, an error message will appear.

2 sources of measurement: Hand Pulse or Chest Strap. The input and connections are located on the back of the display.

The chest strap is recommended for Heart Rate Oriented Programs (HRC).  
NOT INCLUDED.

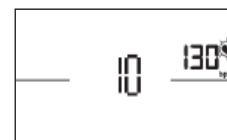

## CARE AND MAINTENANCE

---

**⚠ WARNING**

**IMPORTANT INFORMATION**

Before cleaning or carrying out any maintenance on your elliptical, ensure the power is turned off and the power cord removed from the plug socket.

Prolong the life of your elliptical by performing periodic maintenance checks. Not only does this ensure your machine is in full working order to ensure they continue to run smoothly and reliably, but it will save you service costs in the long run.

### **Cleaning**

General cleaning of the unit after use will protect the ellipticals powder-coated framework and prevent unnecessary corrosion stains and damage to the structural components from sweat and perspiration. During this time check for any cracks and damage.

### **Pivot points**

No matter what style of elliptical trainer you have there will be areas where the arms and legs rotate on an axle or bolt. These pivot points need to be tightened enough so there is still movement in the desired direction of travel but no sideways movement.

Excessive sideways movement causes knocking noises and extra wear. Crosstrainers with a sealed bearing on the axle do not require greasing however units with a plastic or brass bushing should be greased twice a year with general purpose automotive grease between the axle and bush. This ensures that the moving parts are not rubbing directly on one another and causing wear.

### **Joins in frame**

Areas where the frame is bolted together (e.g. the upright mast to the base or the stabiliser legs to the base) need to be kept really tight. Any movement in these areas can cause knocking or squeaking noises during use. It pays to check once every couple of months that things haven't loosened off. Using a thread-locking compound is encouraged but it's still not a permanent solution, checking on a regular basis is the best bet to keep your machine running as best it possibly can.



# LIMITED WARRANTY

---

## Warranty Range

Damage in correct maintenance and normal operations (not factitious factors). Warranty card to the original purchaser, shall not be transferred.

## Warranty Time

### HOME USE

- 10 Year Frame
- 1 Year Parts and Labour

*The following conditions are not under warranty range:*

- A) As a result of abuse, neglect, accident, or unauthorized modification;
- B) The damage due to incorrect adjustment of the machine;

*The Elliptical should not be:*

- A) Plugged into a multi-board plug device. The elliptical requires a dedicated power circuit and should be plugged directly into the wall socket.
- B) Used with an extension cord any longer than 1.5m.

## Repair and Maintenance Service

Please contact our Elite Fitness Service Department at [eliteservice@elitefitness.co.nz](mailto:eliteservice@elitefitness.co.nz) or visit [www.elitefitness.co.nz](http://www.elitefitness.co.nz) for any service related issues or advice on preventative maintenance servicing procedures.

## WARM-UP EXERCISE

Warm up exercise is important in preparing the muscles for activity whilst minimising the risk of injury. You may choose to warm up with a light/brisk walking pace for 5-10 minutes before stopping and performing some simple stretches. (As shown in the pictures below)

### — Hamstring Stretch (Standing)

Keep your knees slightly bent and slowly lean forward, back and shoulders relaxed, reaching towards your toes. You should feel the tension and slight discomfort in your hamstring muscles. Hold for 15-20 seconds. Repeat 2-3 times.

### — Hamstrings Stretches (Seated)

Sitting on the floor preferably on a mat, put one leg straight, the other inward and close to the inside of the straight leg. Lean forward from the hips, reaching towards your toes. Hold for 10-15 seconds, and relax. Repeat 3 times for each leg (See picture 2).

### — Crus and Feet Tendon Stretches

Standing with two hands on the wall or tree, one leg behind. Keeping your legs straight and the heel on the ground, lean forward towards the wall or tree. Hold for 10-15 seconds, and relax. Repeat 3 times for each leg (See picture 3).

### — Quadriceps Stretches

Keeping your balance with your left hand holding onto a wall or stationery fixture, grasp your right foot with your right hand and stretch your right heel toward your buttocks slowly, until you feel the stretch in the front of your thigh. Hold for 10-15 seconds, and relax. Repeat 3 times for each leg (See picture 4).

### — Sartorius (Inner Muscles of the Thigh) Muscle Stretches

Sitting down with the soles of your feet or shoes together and your knees positioned outward. Pull your feet towards your groin until you can feel the stretch. Hold for 10-15 seconds, and relax. Repeat 3 times (See picture 5).

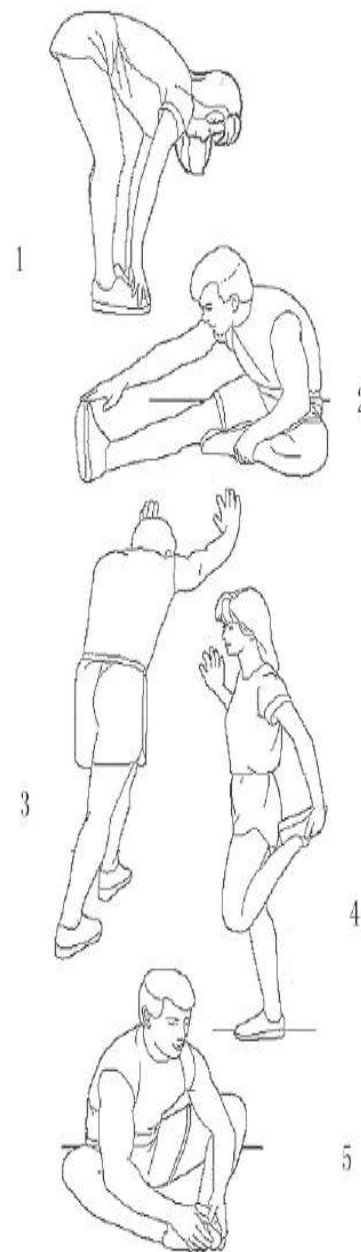

# TRAINING STAGES

		Exercise Zone									
		AGE									
Beats Per Minute	100%	200	195	190	185	180	175	170	165	155	150
	<b>VO2 Max (Maximum Effort)</b>										
	90%	180	176	171	167	162	158	153	149	140	135
	<b>Anaerobic (Hardcore Training)</b>										
	80%	160	156	152	148	144	140	136	132	124	120
	<b>Aerobic (Cardio Training/Endurance)</b>										
	70%	140	137	133	130	126	123	119	116	109	105
<b>Weight Control (Fitness/Fat Burn)</b>											
60%	120	117	114	111	108	105	102	99	93	90	
<b>Moderate Activity (Maintenance/Warm up)</b>											
50%	100	98	95	93	90	88	85	83	78	75	

Cardiovascular training plays an important part in maintaining a healthy heart and lung function, so it's no surprise we should be paying attention to how quickly our heart beats during exercise. The chart above outlines a range of heart rate training zones determined by the individual's age and workout goals to ensure you train safely and effectively.

Heart Rate can be measured by using the radial (wrist) or carotid (neck) pulse using your index and middle fingers, counting the beats for 10 seconds and multiplying by 6. Alternatively, the use of a Wireless Telemetry Heart Rate strap and watch will give you an accurate Beats Per Minute (BPM) reading.

$220 - \text{AGE} = \text{TMHR}$  (Theoretical Maximum Heart Rate)

$\text{TMHR} \times 85\% = \text{(Upper Training Limit) BPM}$

$\text{TMHR} \times 65\% = \text{(Lower Training Limit) BPM}$

Note: Contact heart rate may provide inaccurate readings and is designed only as a guide

Example:  $220 - 39 = 181 \text{ BPM}$

$181 \times 85\% (0.85) = 154 \text{ BPM}$  (Upper Training Limit)

$181 \times 65\% (0.65) = 118 \text{ BPM}$  (Lower Training Limit)



For more information about our Elite exercise equipment or other brands that we stock for your home, visit [www.elitefitness.co.nz](http://www.elitefitness.co.nz)

Copyright © 2023 Elite Fitness

Elite Fitness, 28 Morrin Road, Saint Johns, Auckland, New Zealand.  
0800 243 834, [www.elitefitness.co.nz](http://www.elitefitness.co.nz)

Keep up to date with the latest products, competitions and equipment, follow us on our social media sites.



[@EliteFitnessNZ](https://www.instagram.com/EliteFitnessNZ)

[@EliteFitnessTV](https://www.youtube.com/EliteFitnessTV)